

Ref: 38.019

Features:

- Protection against transient main peaks up to 2KV (between L and N) and up to 4KV (between L/N and PE).
- Electrical short-circuit protection
- Overtemperature protection
- Protection against “no load” operation
- Degree of protection: IP20
- Protection class I



Electrical characteristics	Power	70W - 120W
	Voltage 50-60 Hz (V)	220V - 240V
	Main current mA	590mA - 540mA
	Inrush current A / μ s	52.5A / 270A
	Current output DC mA (\pm 5%)	500mA / 700mA
	Voltage output DC (min-max “V”)	88-280V
	THD %	<10%
	Efficiency at full load % (230V)	>96%
	Ripple 100 Hz	<3%
	Resistors	14.29k Ω (350mA) / 10.00k Ω (500mA) / 7.14k Ω (700mA)
Maximum ratings	Ambient temperature range $^{\circ}$ C min.	-25 $^{\circ}$ C
	Ambient temperature range $^{\circ}$ C max.	+50 $^{\circ}$ C
	Operation humidity range % min.	20%
	Operation humidity range % max.	60%
	Storage temperature range $^{\circ}$ C min.	-40 $^{\circ}$ C
	Ambient temperature range $^{\circ}$ C max.	+85 $^{\circ}$ C
	Storage humidity range % min.	5%
	Storage humidity range % max.	95%
	Max. operation temperature at t_c point $^{\circ}$ C	+80 $^{\circ}$ C
Degree of protection	IP20	
Expected service life time	Operation current Max.	70 $^{\circ}$ C - 80 $^{\circ}$ C
	Operation current hrs.	100,000h - 50,000h
Dimming	Dimmable	no
	DALI power supply integrated	no
	DALI power supply switchable	no
Other	Dimension	280x30x21mm
	Casing shape	M7.1
	Weight	212g
	Guarantee	5 years



Measurements:

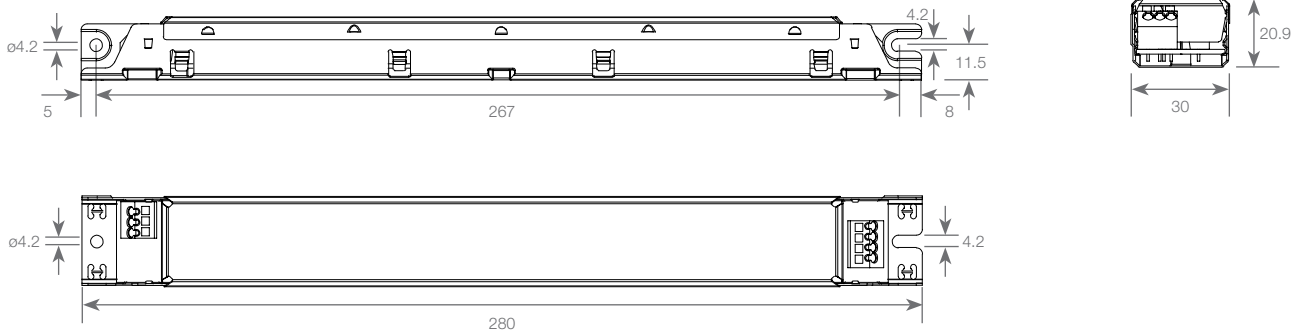
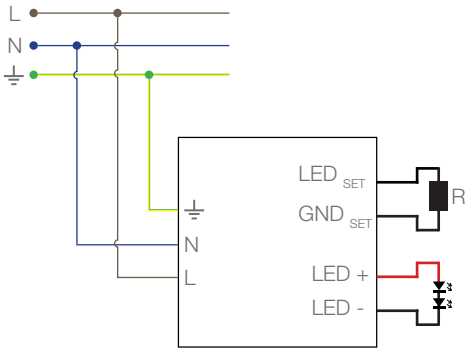
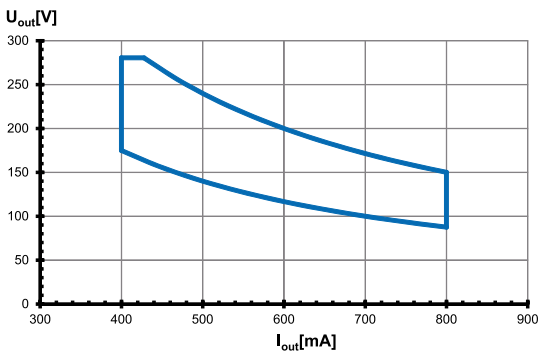

Diagram:



Type performance graphs / Type EDXe

Working area



Efficiency

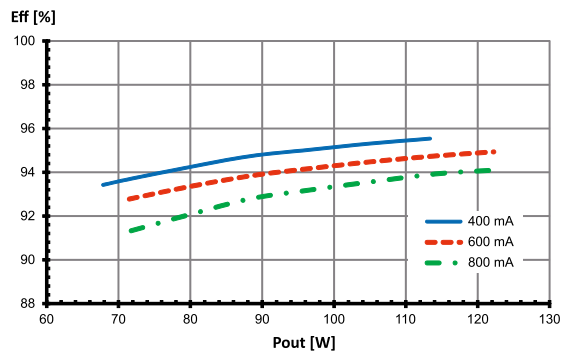

Power factor

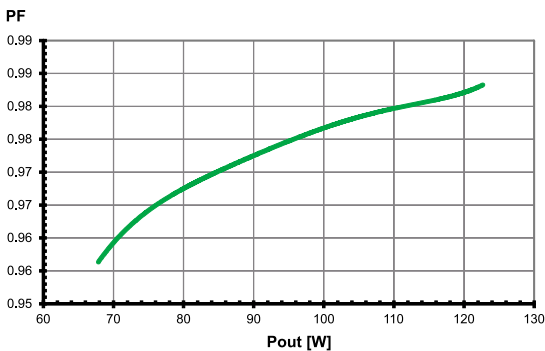

Total harmonic factor (THD)

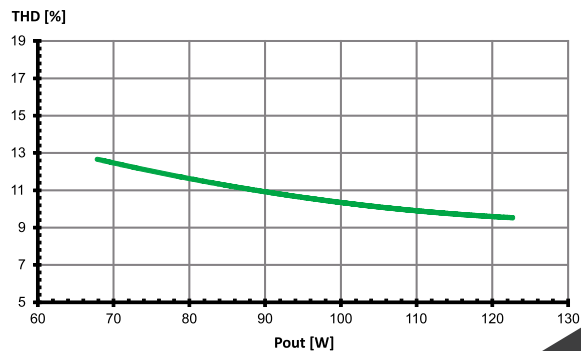

Assembly and Safety Information

Applied standards:

- EN 61347-1
- EN 61347-2-13
- EN 61547
- EN 61000-3-2
- EN 62384
- EN 55015

Mandatory regulations:

- DIN VDE 0100
- EN 60598-1

Safety functions

- **Transient main peaks protection:** values are in compliance with EN 61547 (interference immunity). Surges between L/N: up to 2 kV. Surges between L/N-PE: up to 2 kV.
- **Short-circuit protection:** the control gear is protected against permanent short-circuit with automatic restart function.
- **Overload protection:** the control gear only works in range of rated output power and voltage problemfree. Please check before switch-on main power supply that the selected led load is suitable (see Electrical Characteristics on data sheet).
- **Overheating:** The control gear has overheating protection acc. to IEC 61347-1 C 5e). In case of overheating the control gear will shut down and service life time will reduce.
- **No load operation:** the control gear is protected against no load operation (open load).
- If any of the above mentioned safety functions will be triggered, disconnect the control gear from the power supply then find and eliminate the cause of the problem.

















Mechanical mounting:

- **Mounting position:**
 - Built-in: any position inside a luminaire is allowed.
 - Independent application: drivers are allowed to use for independent applicatons.
- **Mounting location:**
 - led drivers are designed for integration into luminaires or aomparable devices.
 - Installation in outdoor luminaires: degree of protection for luminaire with water protection rate ≥ 4 (e.g. IP54 required).
- **Degree of protection:** IP20
- **Clearance:** min. 0.10m from walls, ceilings and insulation.
- **Surface:** solid and plane surface for optimum heat dissipation required.
- **Heat transfer:**
 - If the led drivers is destined for installation in a luminaire. Sufficient heat transfer must be ensured between the led driver and the luminaire casing.
 - Led drivers should be mounted with the greatest possible clearance to heat soucrs. During operation, the temperature measure at the led driver's t_c point must not exceed the specified maximum value.
- **Fastening:** using M4 screws in the designated holes.
- **Tightening torque:** 0.2 Nm.

Electrical installation:

- **Connection terminals:** push-in terminals for rigid or flexible conductors with a section od 0.2 - 1.5mm².
- **Stripped length:** 8.5–10mm.
- **Wiring:** the main conductor within the luminaire must be kept short (to reduce the induction of interference). Main and lamp conductors must be kept separate and if possible should not be laid in parallel to one another.
- **Polarity:** please ensure the correct polarity of the leads prior to commissioning. Reversed polarity can destroy the modules.
- **Through-wiring:** is not allowed.
- **Secondary load:** the sum of forward voltages of led loads is within the tolerances which are mentioned in the Electrical Characteristics on the data sheet.

Product labels:

	INPUT	 VS LIGHTING SOLUTIONS Vossloh-Schwabe Deutschland GmbH Holte Sternstr. 8, D-58559 Lüdenscheid Electronic converter for LED Type ECKe 800.262 Ref-No. 185693 Made in Serbia (Europe)	 EN 61347-1  EN 61347-2-13  EN 62384  EN 61547  EN 55015  EN 61000-3-2	 LED set 1		OUTPUT <table border="1"> <tr> <td>Rated (mA)</td> <td>400...800 mA</td> <td>LED</td> </tr> <tr> <td>Rated (V)</td> <td>88...280</td> <td>LED</td> </tr> <tr> <td>Rated (W)</td> <td>70...120</td> <td>LED</td> </tr> <tr> <td>to (°C)</td> <td>90</td> <td>GNDist</td> </tr> <tr> <td>to (°C)</td> <td>-25...+50</td> <td>LEDset</td> </tr> <tr> <td>Usur (V)</td> <td><300</td> <td></td> </tr> </table>	Rated (mA)	400...800 mA	LED	Rated (V)	88...280	LED	Rated (W)	70...120	LED	to (°C)	90	GNDist	to (°C)	-25...+50	LEDset	Usur (V)	<300	
	Rated (mA)						400...800 mA	LED																
Rated (V)	88...280	LED																						
Rated (W)	70...120	LED																						
to (°C)	90	GNDist																						
to (°C)	-25...+50	LEDset																						
Usur (V)	<300																							
	Range of application DC 198...276 V	    	Non isolated																					